

# MARKUS

## MWVT 80

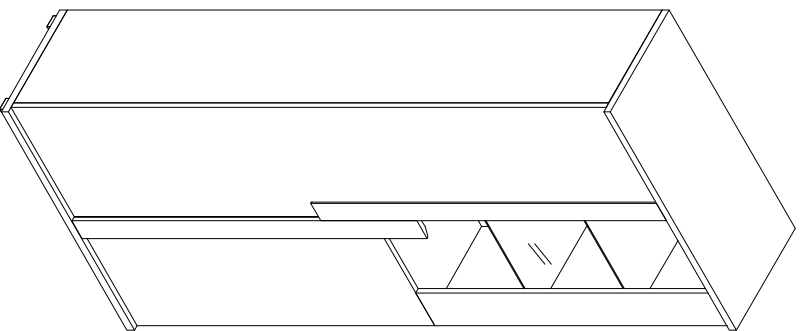

22.03.2016

- (D) Montageanleitung
- (FR) Notice de montage
- (NL) Handleiding voor de montage
- (CZ) Montážní návod
- (HU) Szerelési útmutató
- (TR) Montaj talimatı
- (GB) Assembly Instructions
- (IT) Istruzioni di montaggio
- (PL) Instrukcja montażu
- (SK) Návod na montáž
- (RO) Instrucțiunile de montaj
- (RU) Инструкции по монтажу

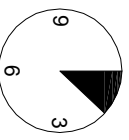
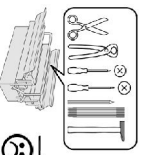

1-1,5

1

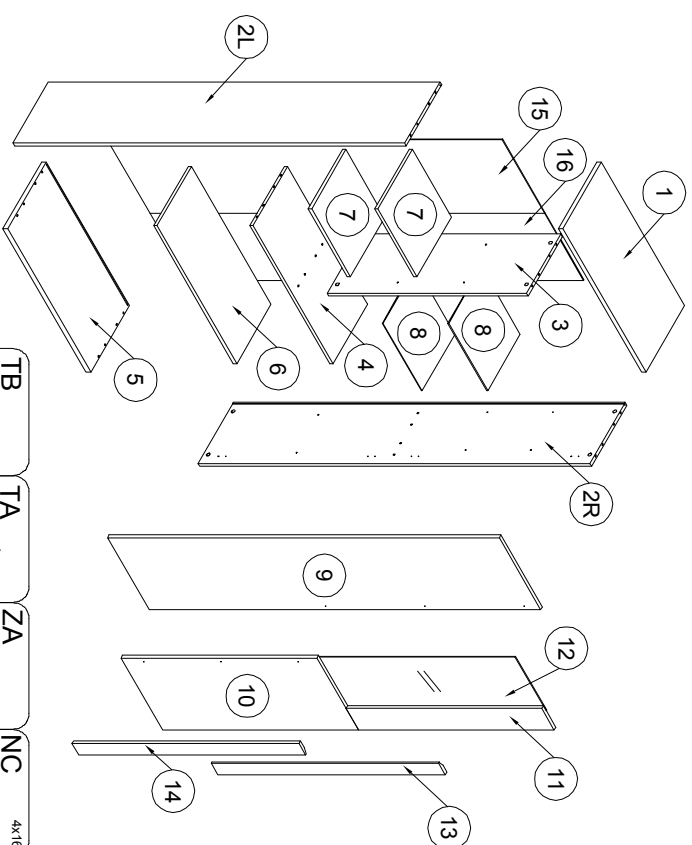

Z	GLUE	AB	NF	TB	TA	ZA	NC	S
X12	X1	8x38	4x30	X1	X1	X2	4x16	L-902mm X1
ZE	AB	8x32	4x13	NA	P	X	N	ZC
X8	X2	8x32	4x13	X1	X8	X10	3x20	X7
A	NA	B	R	H	C	Y	Z	
X16	X17	X16	X8	X16	X16	X4	X16	

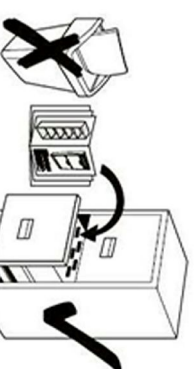
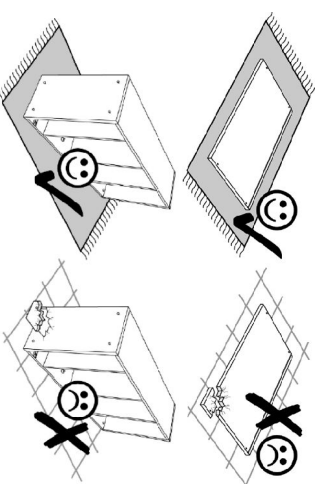

2

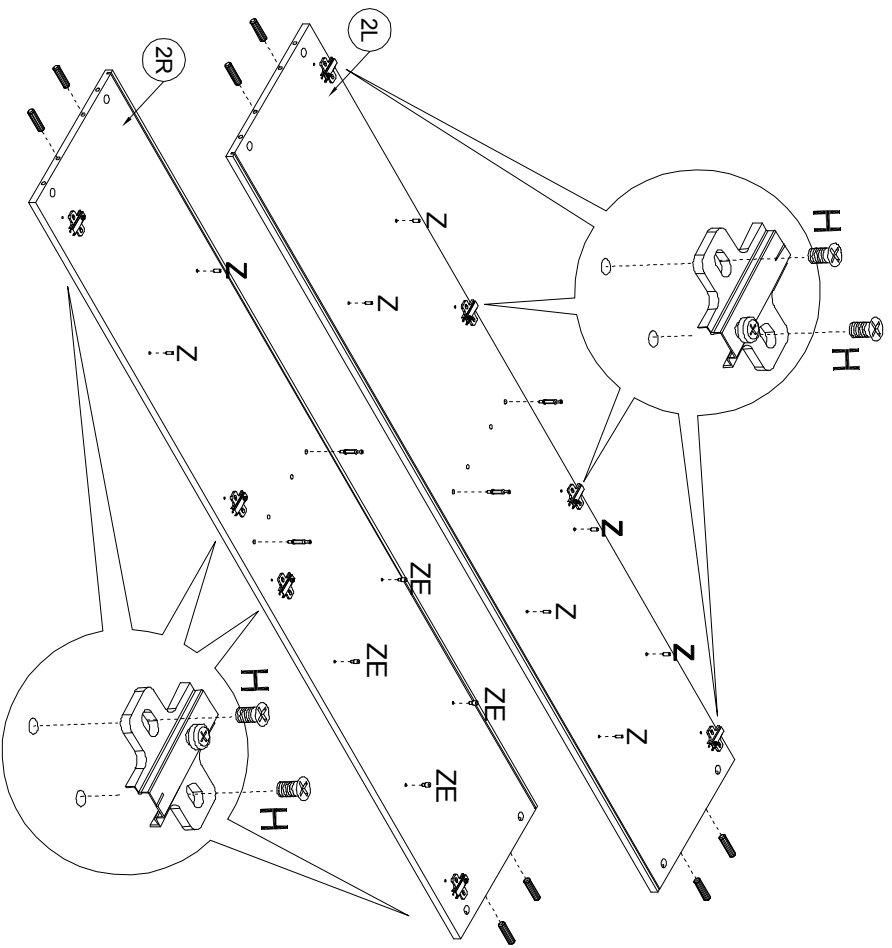
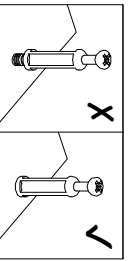

- Z x8
- ZE x4
- A 8x32 x8
- B x4
- R x8
- H 6.3x13 x16

3

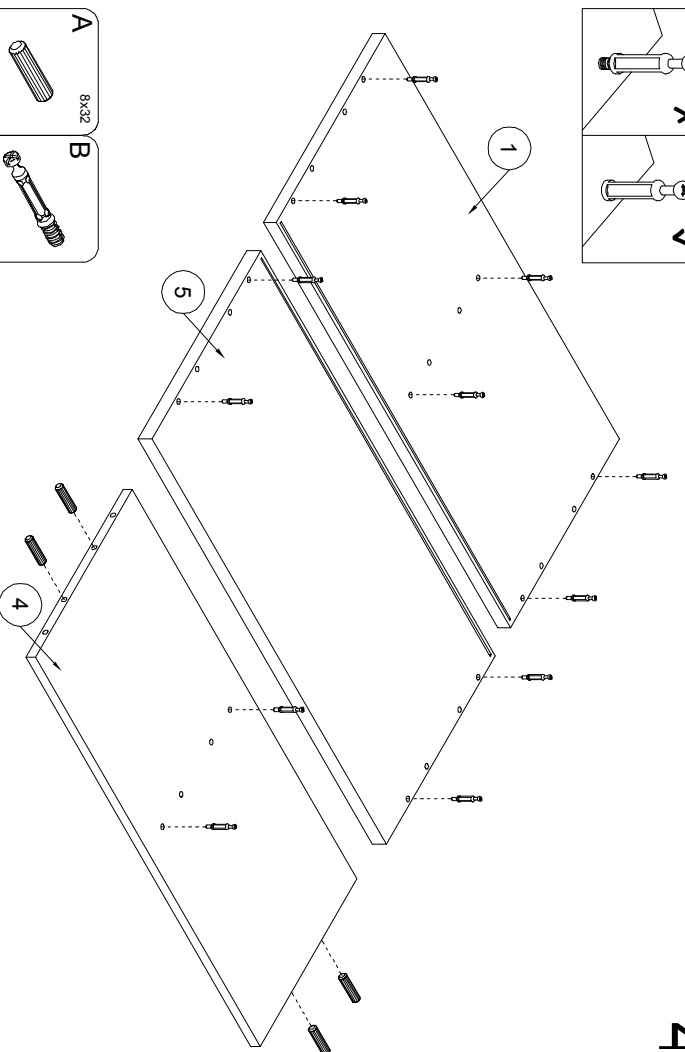
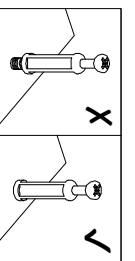

- A 8x32 x4
- B x12

4

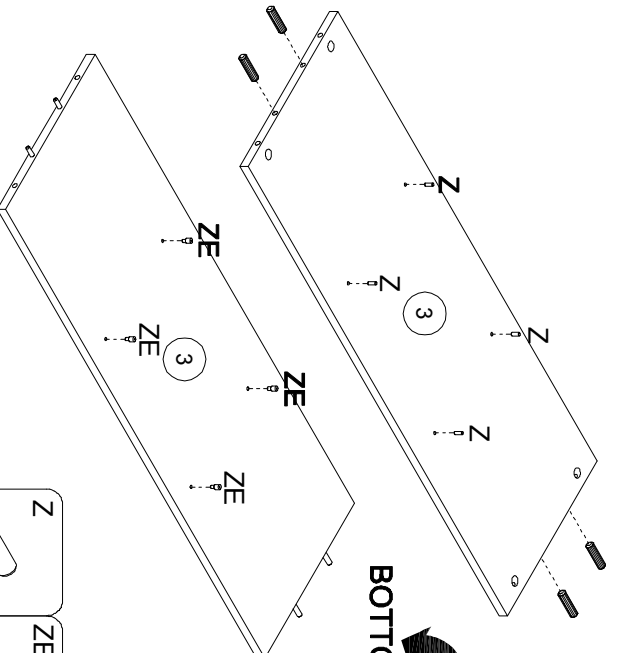

- Z x4
- ZE x4
- A 8x32 x4

5

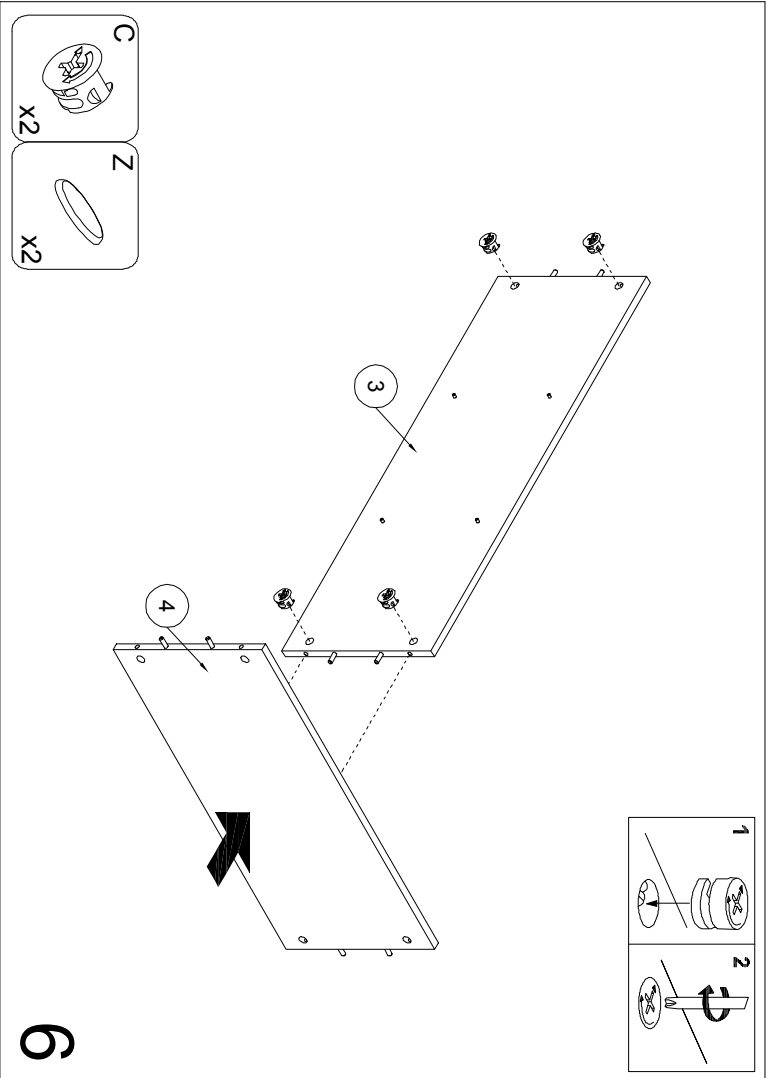

6

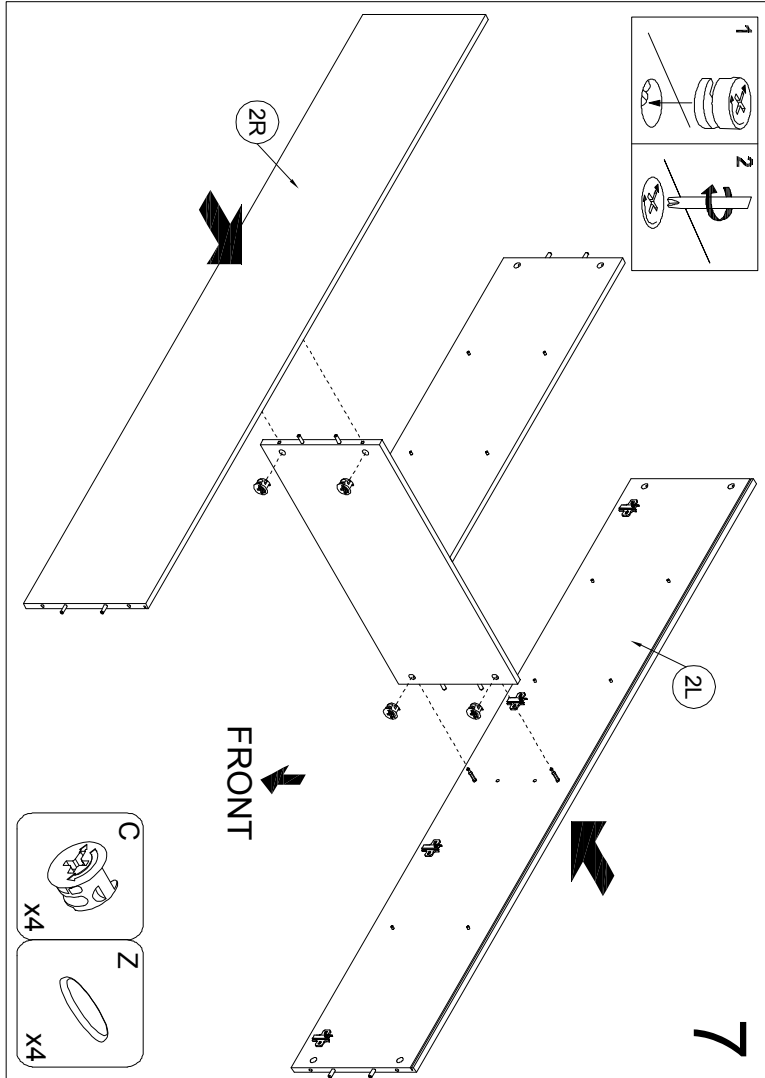

7

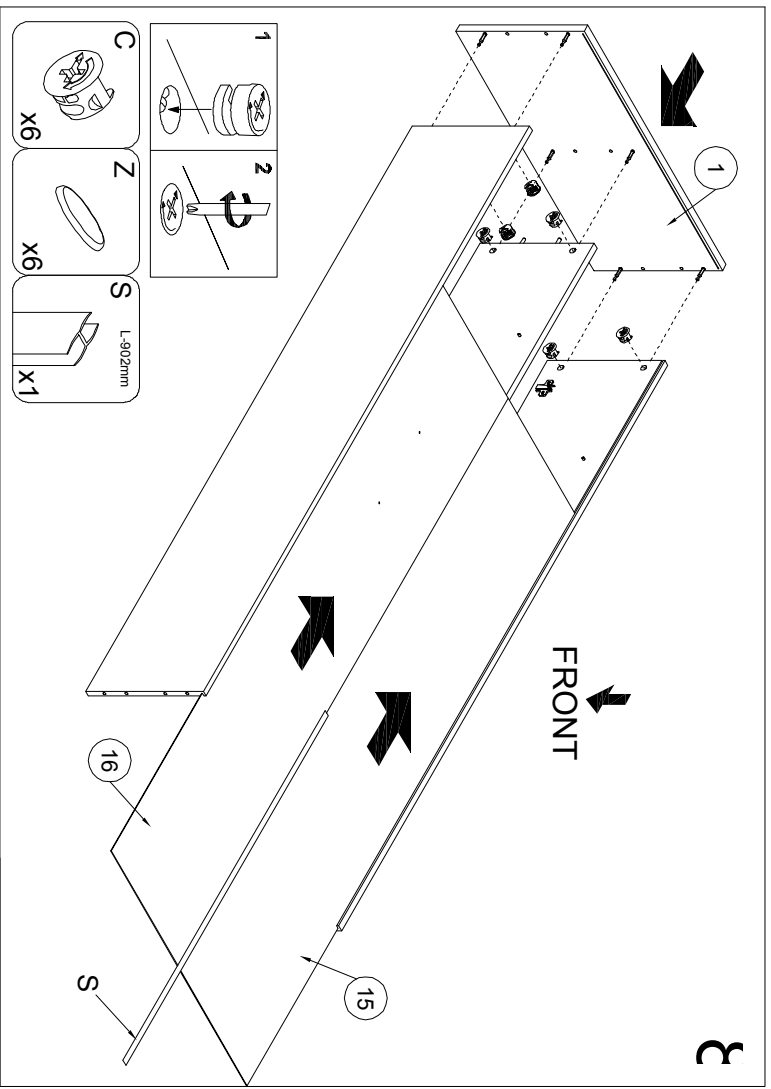

8

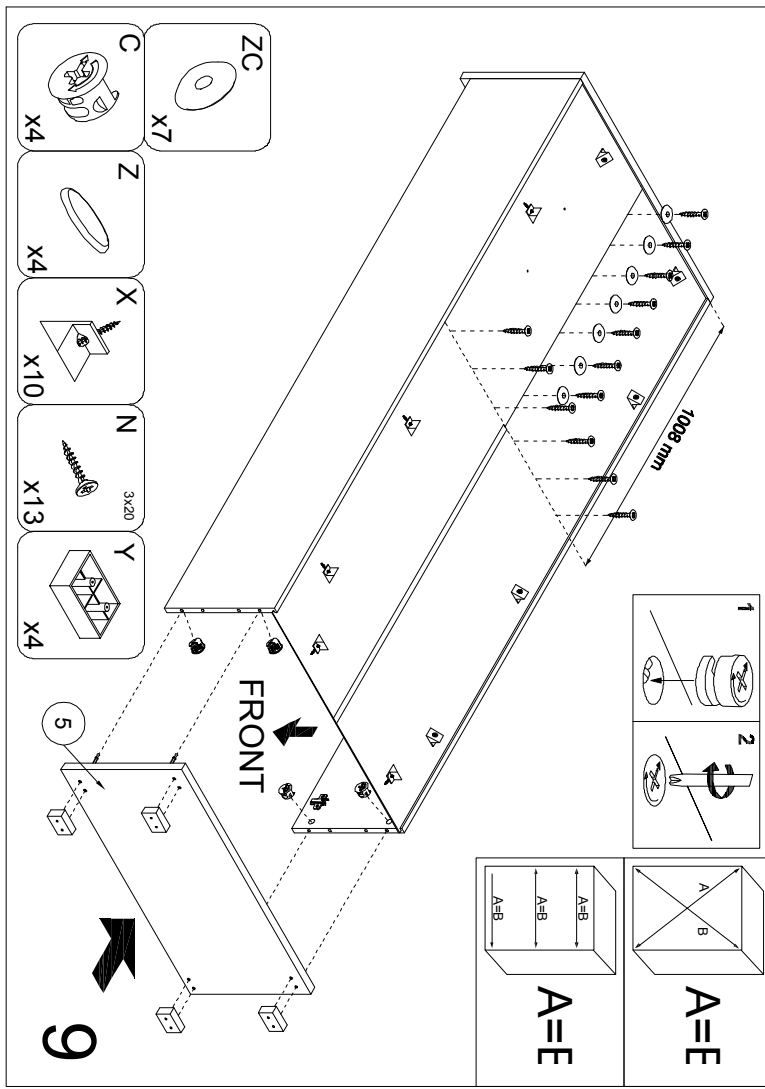

9

10

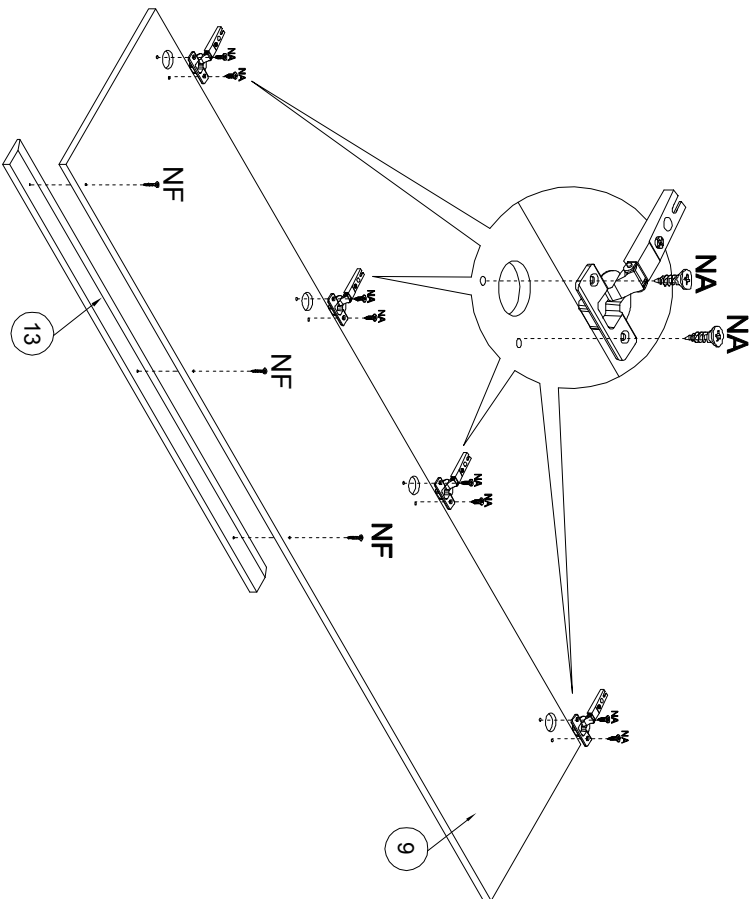

- NF 4x30 X3
- NA 4x13 X8
- P X4

11

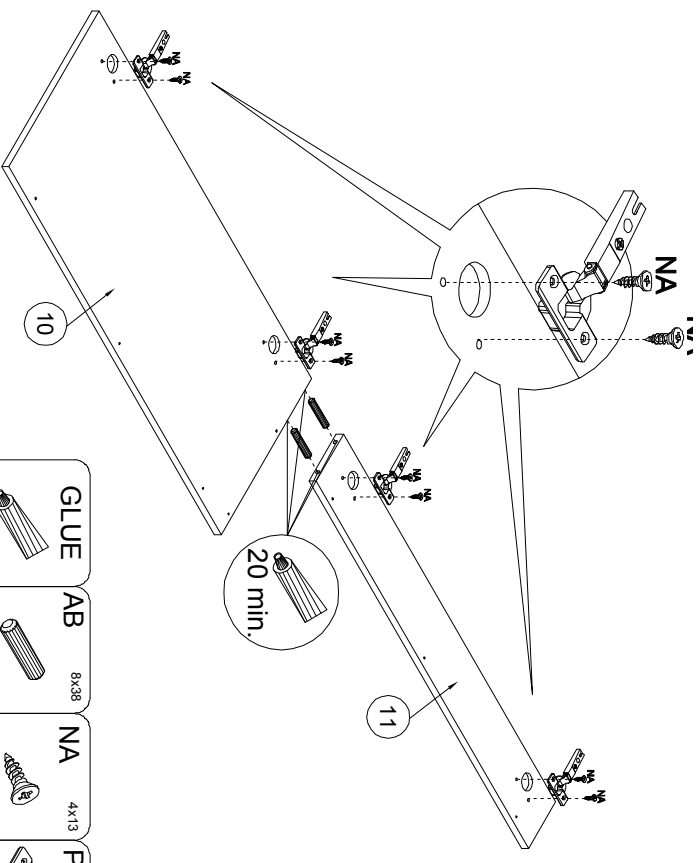

- GLUE X1
- AB 8x38 X2
- NA 4x13 X8
- P X4

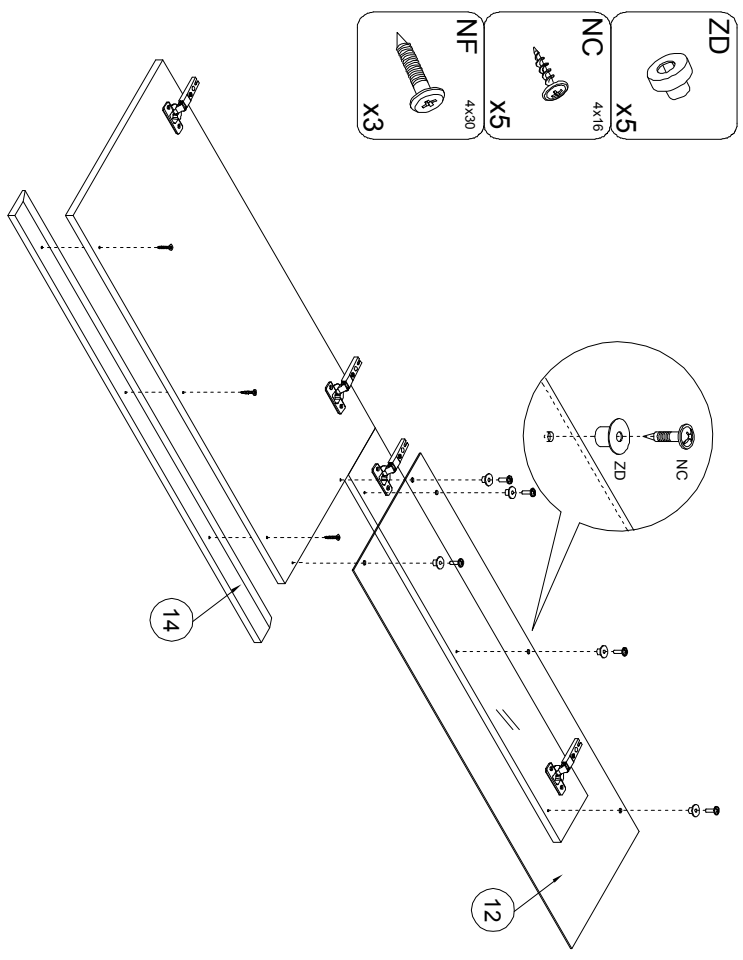

- ZD 4x16 X5
- NC 4x16 X5
- NF 4x30 X3

12

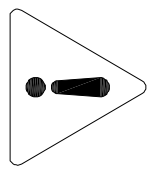
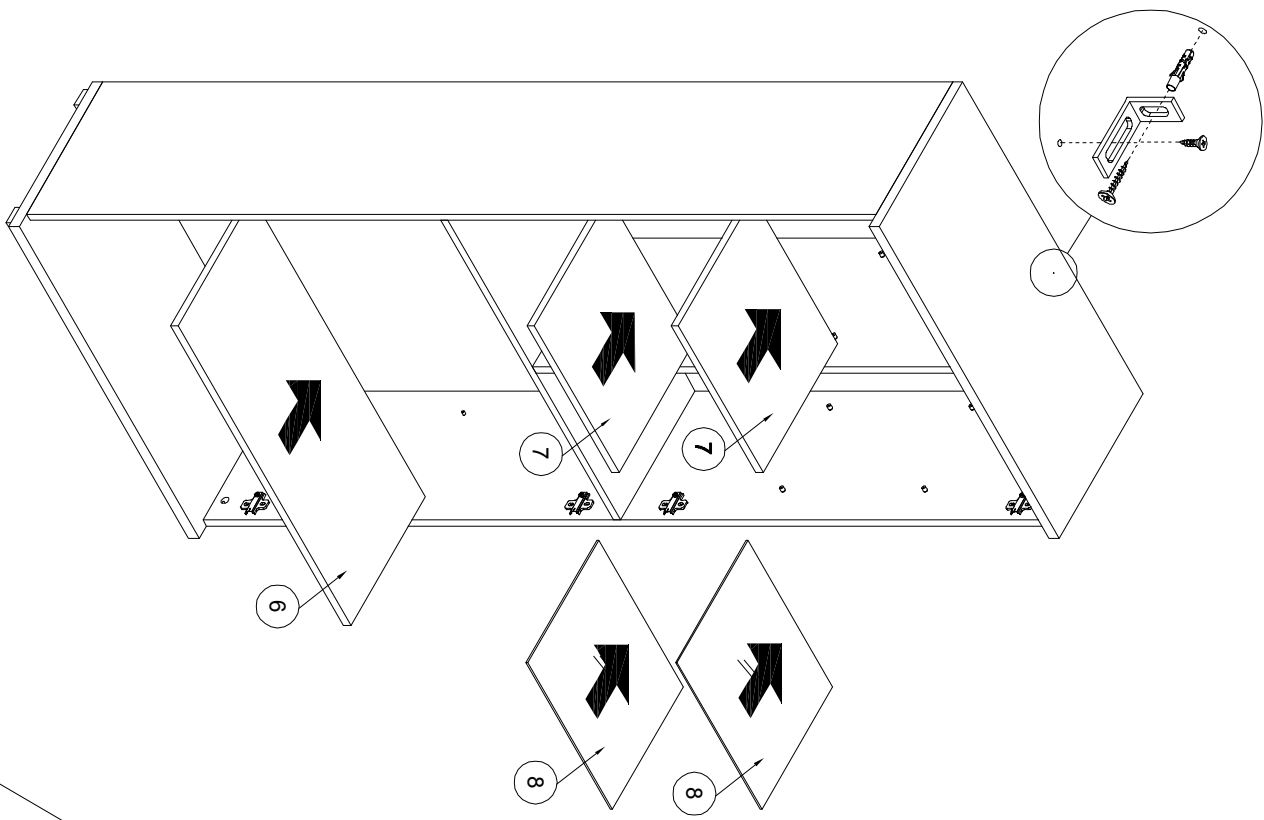

- TB X1
- TA X1
- NA 4x13 X1

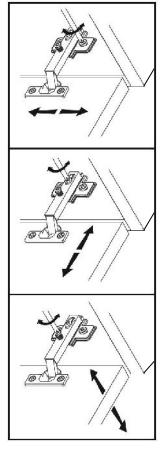
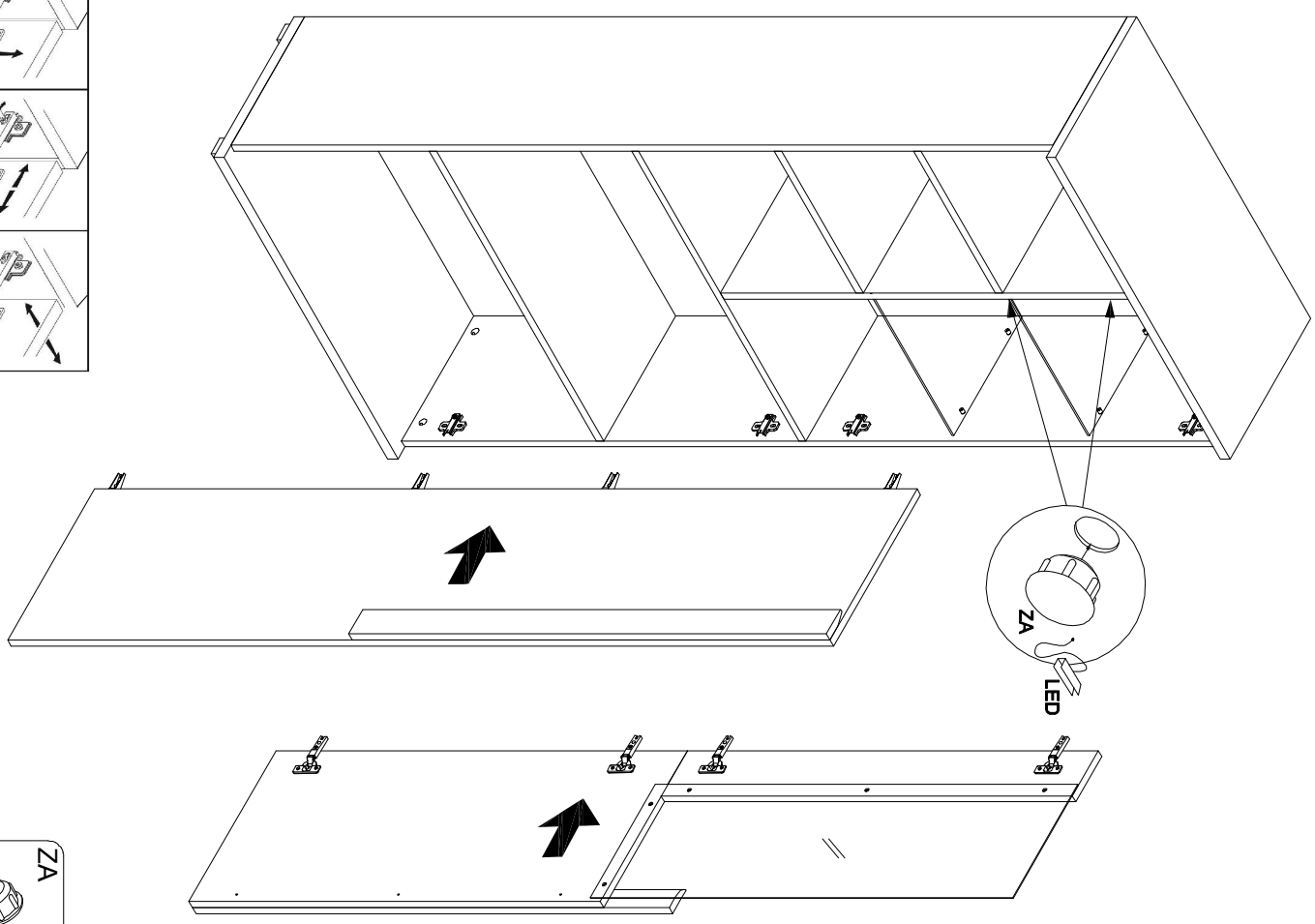

- ZA X2